

PRODUCT CODE: SR50B
EXTENSION RING



DESCRIPTION

50mm Extension Ring

FINISH

Black Enamel

MATERIAL

Steel

PACKAGING

Packed in qty 10

ADDITIONAL NOTES

Conforms to BS EN61386-1

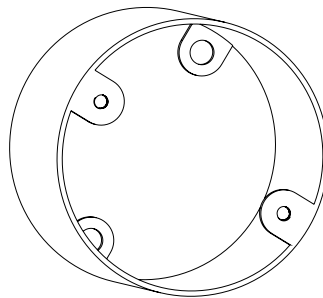

Isometric view

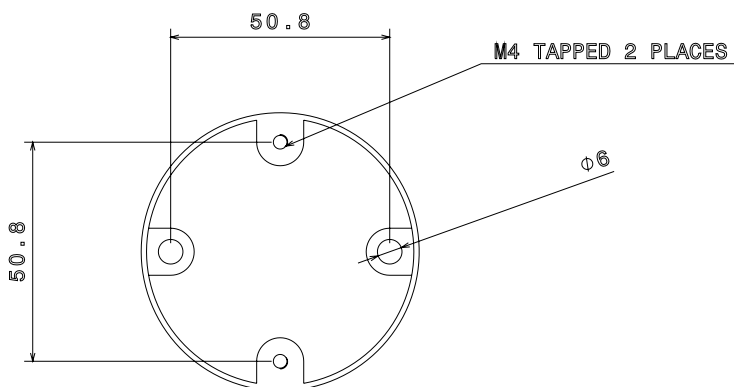

Top view

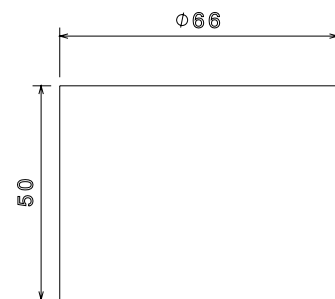

Side view